

► User Instruction

**Snap Top Rail Attachment**

1.

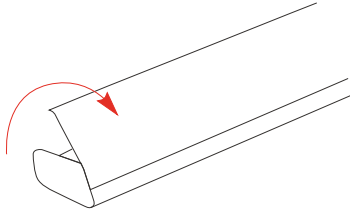

2.

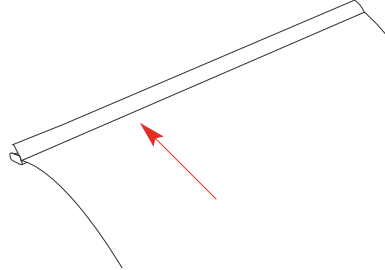

3.

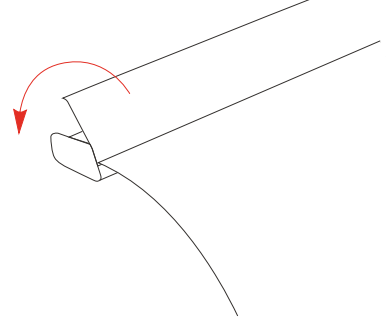

**Bottom Graphic Attachment**

1.



2.

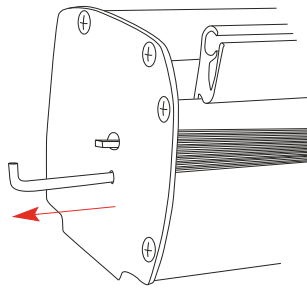

3.

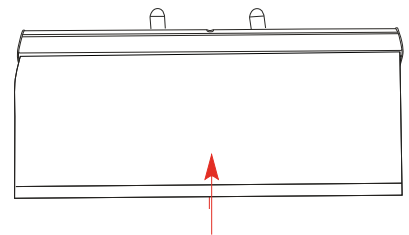

**Assembly**

1.

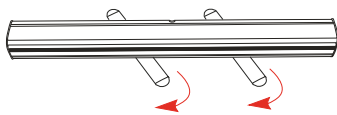

2.

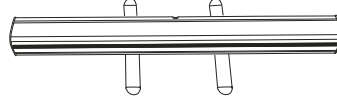

3.

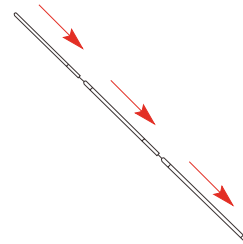

4.

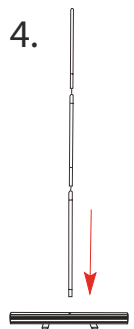

5.

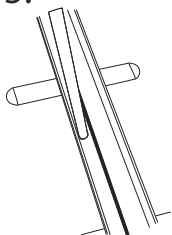

6.

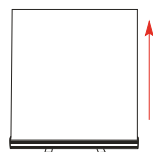

7.

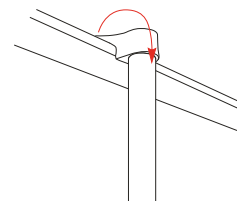

\* We are continually improving and modifying our product range and reserve the right to vary the specifications without prior notice. All dimensions and weights quoted are approximate and we accept no responsibility for variance.

SIA "Print Plus"

Office address: Dzelzceļu iela 22/24, Daugavpils, LV-5401

Office Phone: +371 654 22226 | +371 654 20766 | e-mail: info@printonline.lv | www.printonline.lv

# Roller Banner Mosquito 800 mm

## **NON-VISIBLE AREA**

This area will go into the mechanism, and will not be seen, so no images or logos to go inside this area.

# Roller Banner Mosquito 850 mm

## **NON-VISIBLE AREA**

This area will go into the mechanism, and will not be seen, so no images or logos to go inside this area.

# Roller Banner Mosquito 1000 mm

## **NON-VISIBLE AREA**

This area will go into the mechanism, and will not be seen, so no images or logos to go inside this area.

# Roller Banner Mosquito 1200 mm

## **NON-VISIBLE AREA**

This area will go into the mechanism, and will not be seen, so no images or logos to go inside this area.

# Roller Banner Mosquito 1500 mm

## **NON-VISIBLE AREA**

This area will go into the mechanism, and will not be seen, so no images or logos to go inside this area.

Roller Banner  
Mosquito 2000 mm

**NON-VISIBLE AREA**

This area will go into the mechanism, and will not be seen, so no images or logos to go inside this area.